

## Bodenlager / Floor bearing

WN 058647-45532, 2023-12  
013513

### Wichtige Informationen / Important information

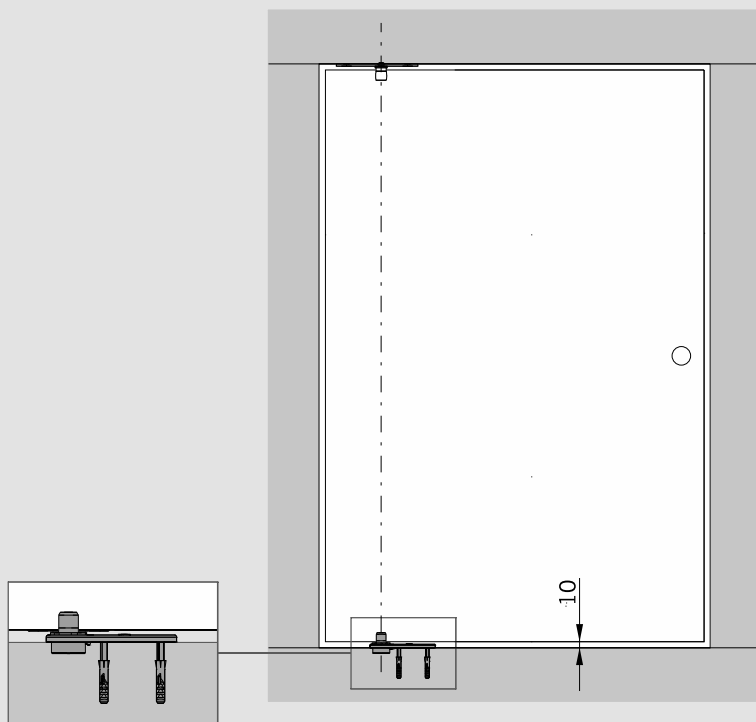

### Lieferumfang / Scope of delivery

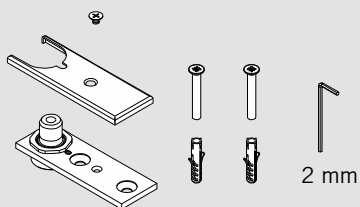

Mitgelieferte Schrauben und Dübel sind nicht für jeden Untergrund geeignet. /  
Delivered screws and plugs are not suitable for all types of foundations.



Geeignete und auf den Untergrund abgestimmte Befestigungsmittel verwenden. /  
Please use suitable fixing material according to foundation.

# MUNDUS

## Bodenlager / Floor bearing

### Montagewerkzeug / Requisite tool

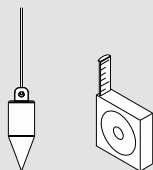
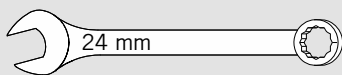
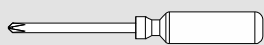

ø8 mm, ø26 mm

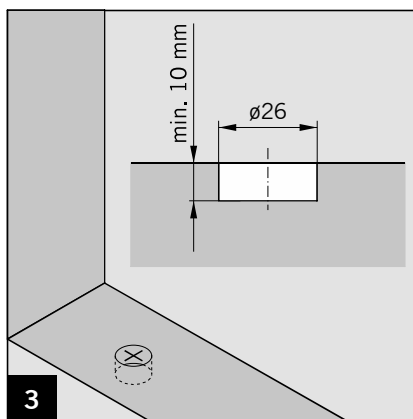
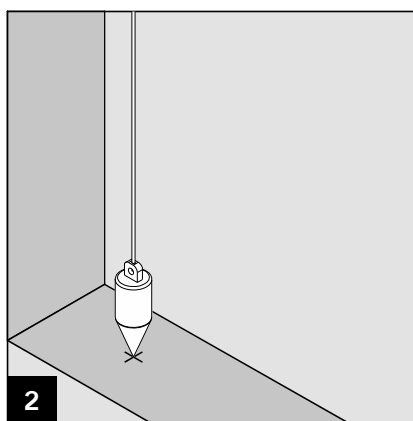
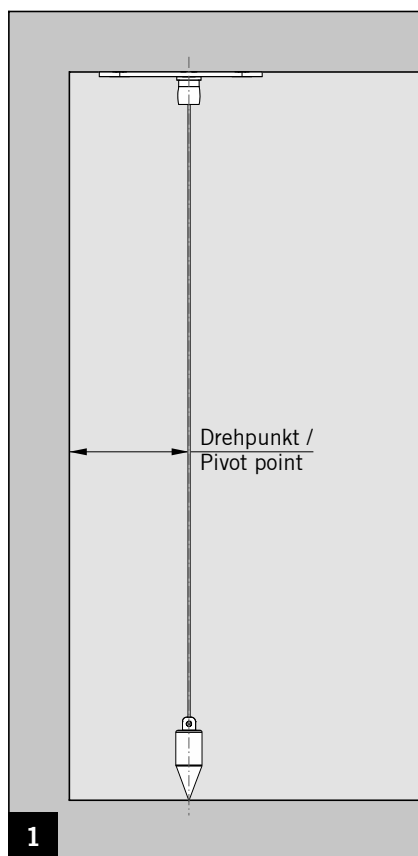

# MUNDUS

## Bodenlager / Floor bearing

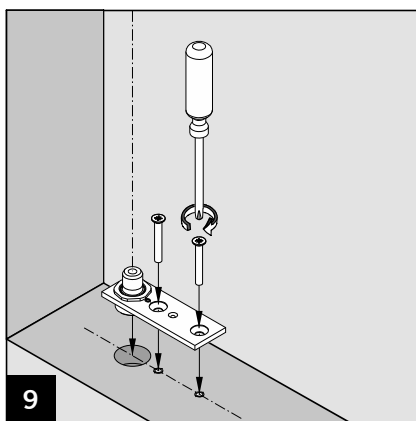
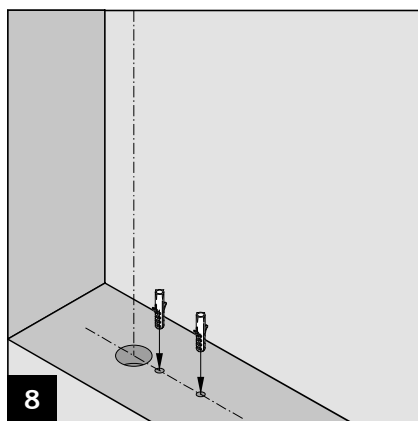
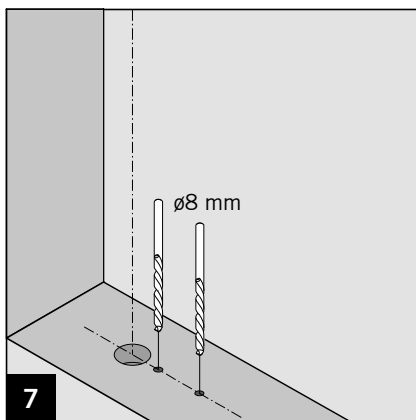
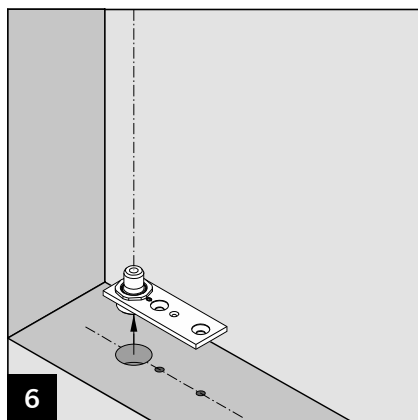
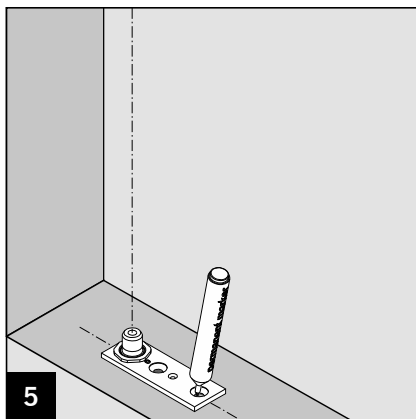
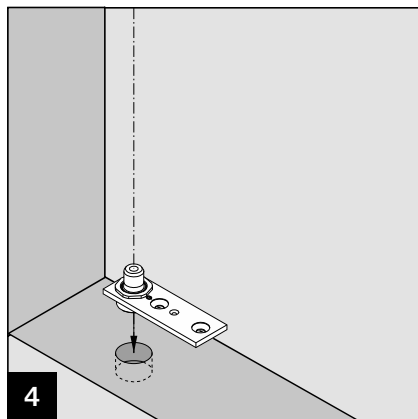

# MUNDUS

## Bodenlager / Floor bearing

